

MODÈLE / MODEL 816

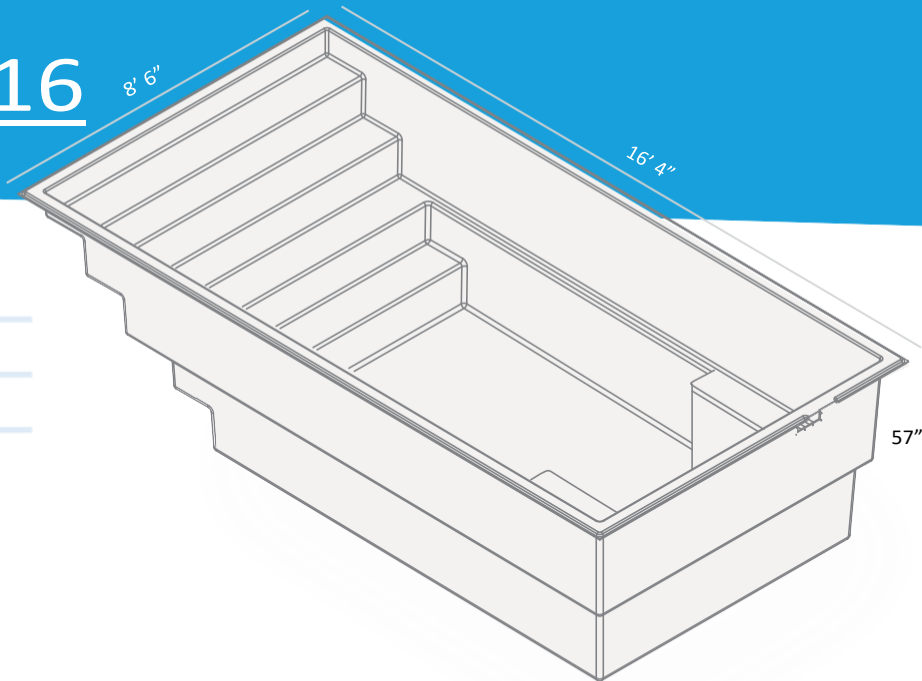

SURFACE	141,04 PI ²
POIDS	750 LIVRES
PÉRIMÈTRE	49 PIEDS LINÉAIRES
VOLUME	402 PIEDS CUBES 3007 GALLONS US 2504 GALLONS IMP. 11383 LITRES

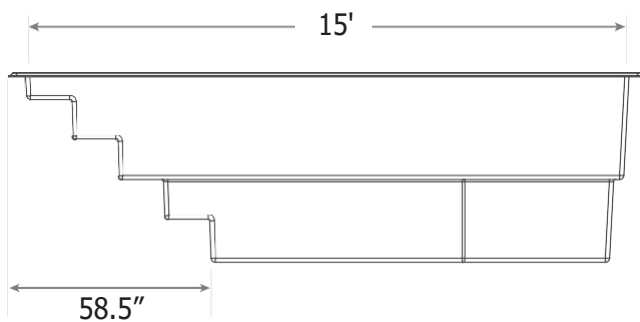
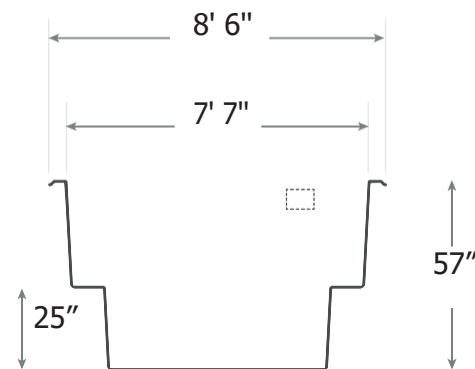
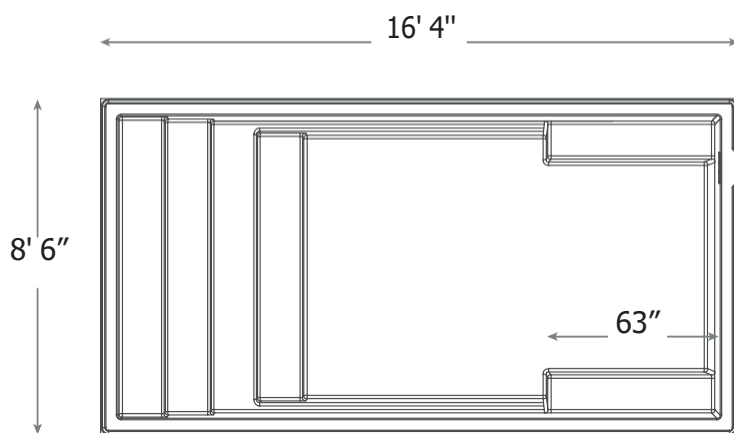

AREA	141,06 SF
WEIGHT	750 POUND
PERIMETER	49 LINEAR FOOT
VOLUME	402 CUBIC FOOT 3007 US GALLONS 2504 IMP. GALLONS 11383 LITRES

GRUPE A1

VOTRE VISION, NOTRE MISSION