

MODÈLE/MODEL 1222

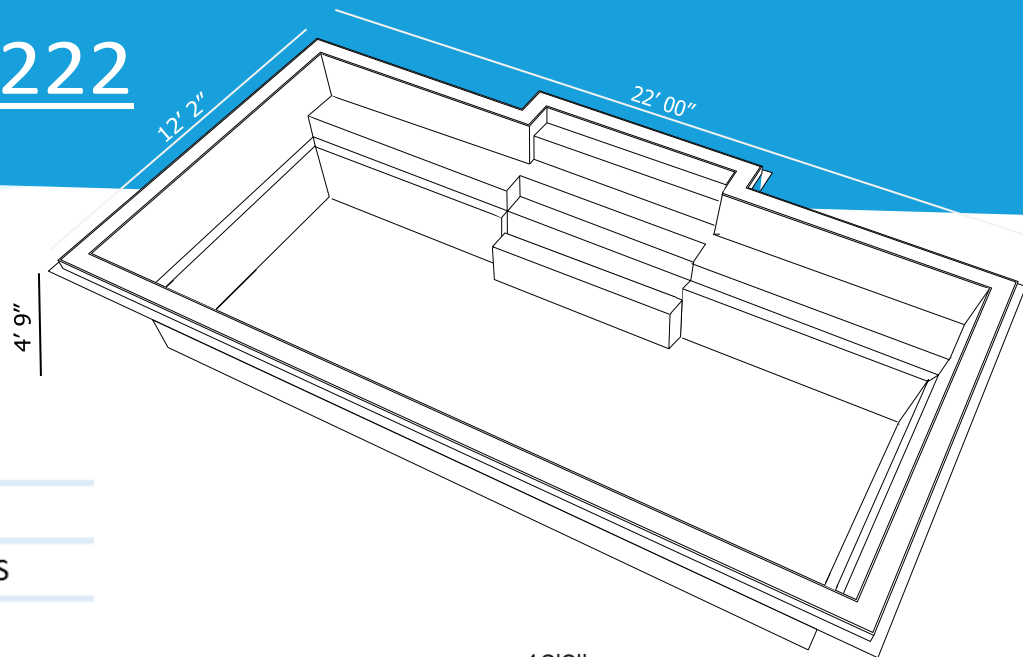

SURFACE	268,4 PI ²
POIDS	1200 LIVRES
PÉRIMÈTRE	63 PIEDS LINÉAIRES
VOLUME	749 PIEDS CUBES 6340 GALLONS US 5279 GALLONS IMP. 23994 LITRES

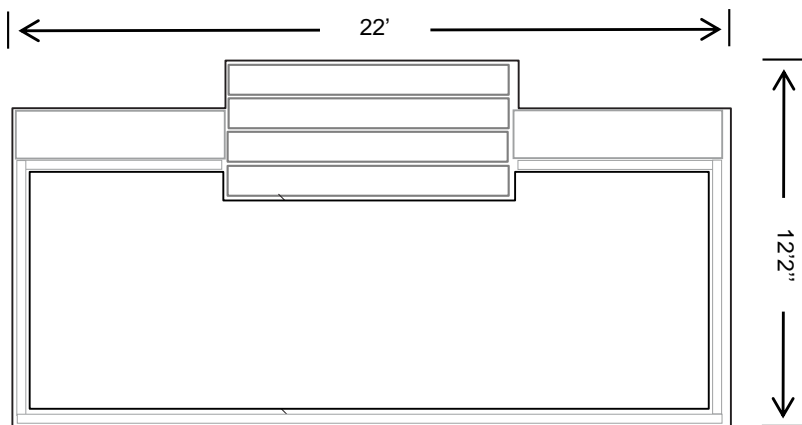
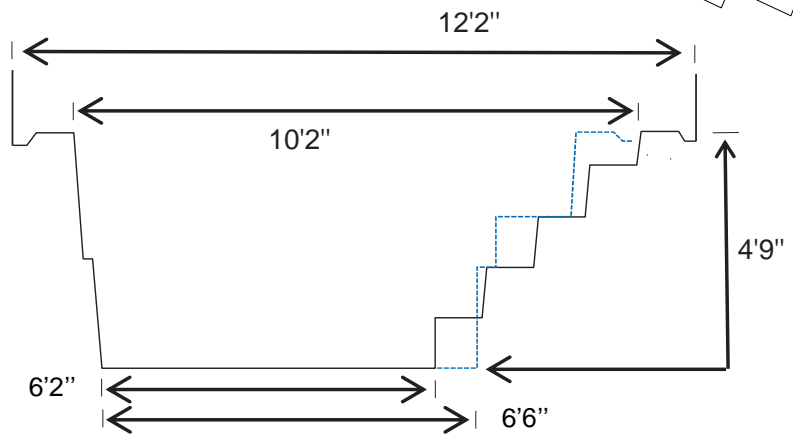

AREA	268,4 SF
WEIGHT	1200 POUND
PERIMETER	63 LINEAR FOOT
VOLUME	749 CUBIC FOOT 6340 US GALLONS 5279 IMP. GALLONS 23994 LITRES

GRUPE A1

VOTRE VISION, NOTRE MISSION